

# EVENT TENT BASIC

Assembly Instructions | R1.042716

## ASSEMBLY HARDWARE

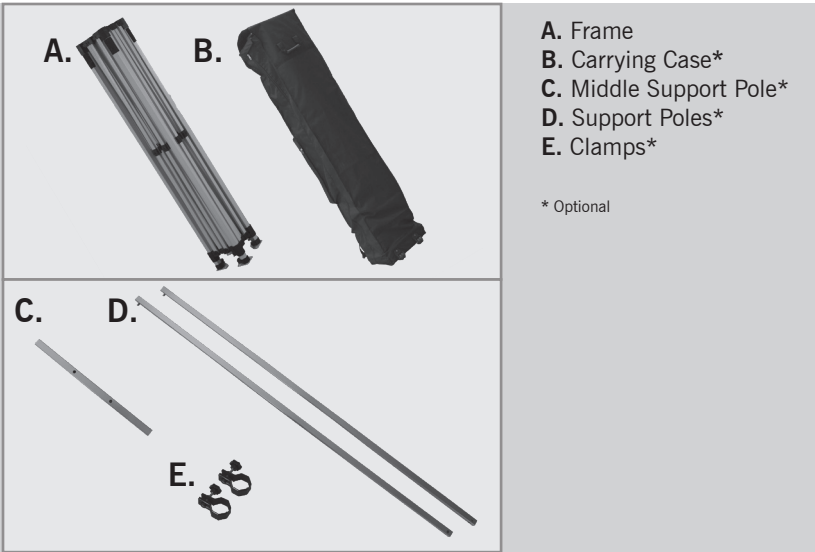

## ASSEMBLY

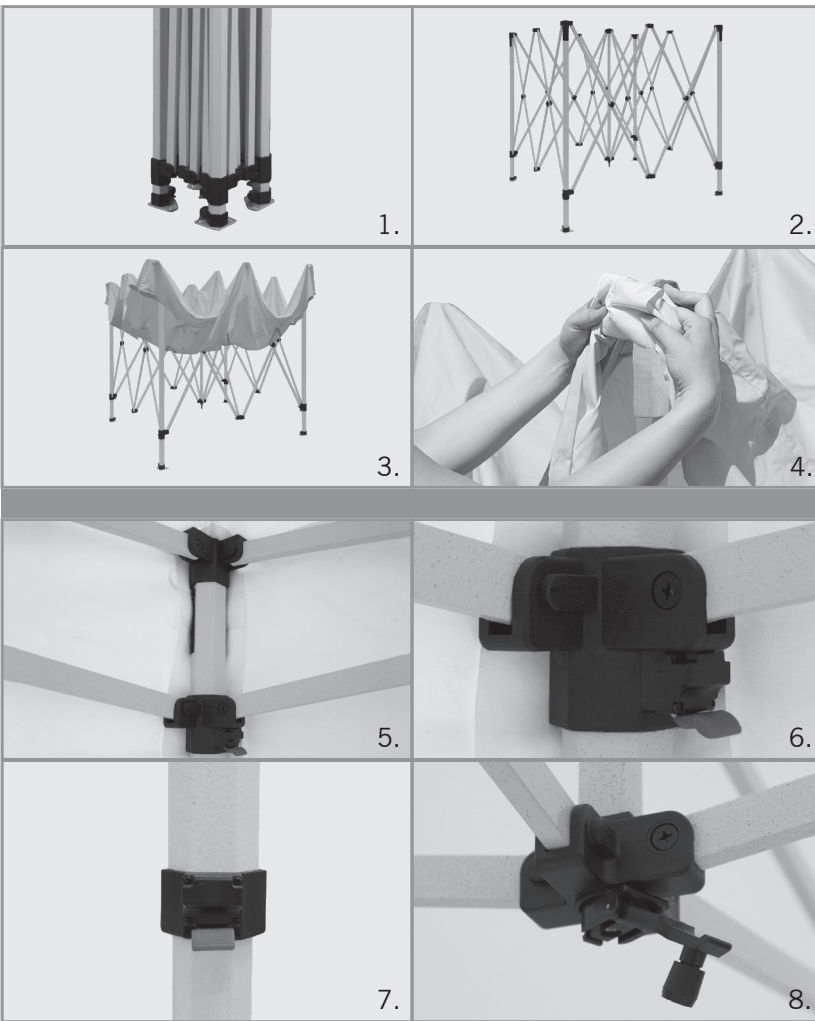

**NOTE: It is recommended to use 2+ people for tent assembly.**

1. Place the frame on the location chosen for assembly. Make sure the feet of the frame are on the ground.
- 2-3. Expand the frame outward, but not fully, and place the tent print over the frame. Make sure the print is facing the correct direction and that the corners of the print line up with the correct corners of the frame.
4. Attach the loop adhesive, located on the inside of the print, to the hook adhesive around the top of the main posts.
- 5-6. Completely expand the frame outward. The locking clips will snap into place to indicate full expansion of the frame.
7. Pull up the legs of the frame to the desired height, making sure the locking clips snap into place. Standing and using your foot to hold down the tent foot makes this step easier.
8. Extend the canopy to its full height by using the rooftop crank adjustment. This will also tighten the print for a wrinkle-free display.

**NOTE: Remove print prior to collapsing and storing the frame. Do not store the frame with the print attached. Treat printed canopy with care to avoid scratching.**

**DISCLAIMER:** Tents should always be staked down with Premium Tent Stake Kit and weighed down. Tents should not be used in inclement weather, including thunderstorms, heavy rains, lightning, and high winds. No grill or any type of open flame is to be used under or near the tent. User must read and observe assembly instructions. If this is not done correctly, it may result in damage to the unit, injury, or death, and all warranties will be void. All warranties will be void if hardware is used with any print not produced by us. Properly care for prints to keep them in great condition. Prints should never be dragged along the ground or stored without being properly folded and free from moisture. Make sure print is completely dried from any weather, and fold and store in a clean, dry place. We don't recommend storing print on frame.



## ASSEMBLY OF WALL(S) - OPTIONAL

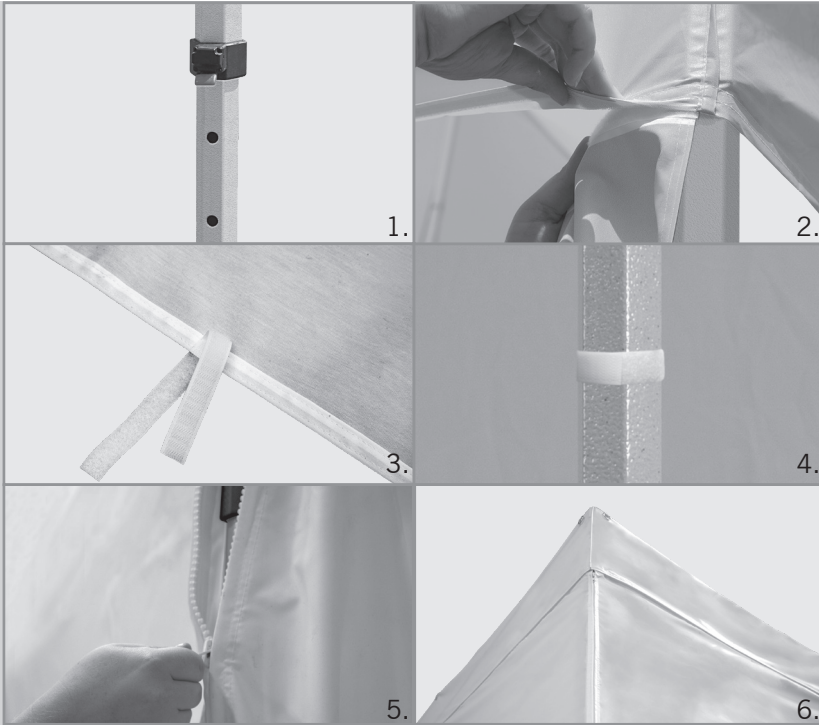

1. When adding the tent wall(s), the legs of the frame must be at their maximum extension height.
2. Attach the wall's loop adhesive to the hook adhesive on the tent valance.
- 3-4. Secure the sides of the wall by wrapping the hook-and-loop adhesive tabs around the tent legs.
- 5-6. If the tent wall features zippers, walls can be connected by closing the zipper from bottom to the top.

## ASSEMBLY OF HALF WALL(S) - OPTIONAL

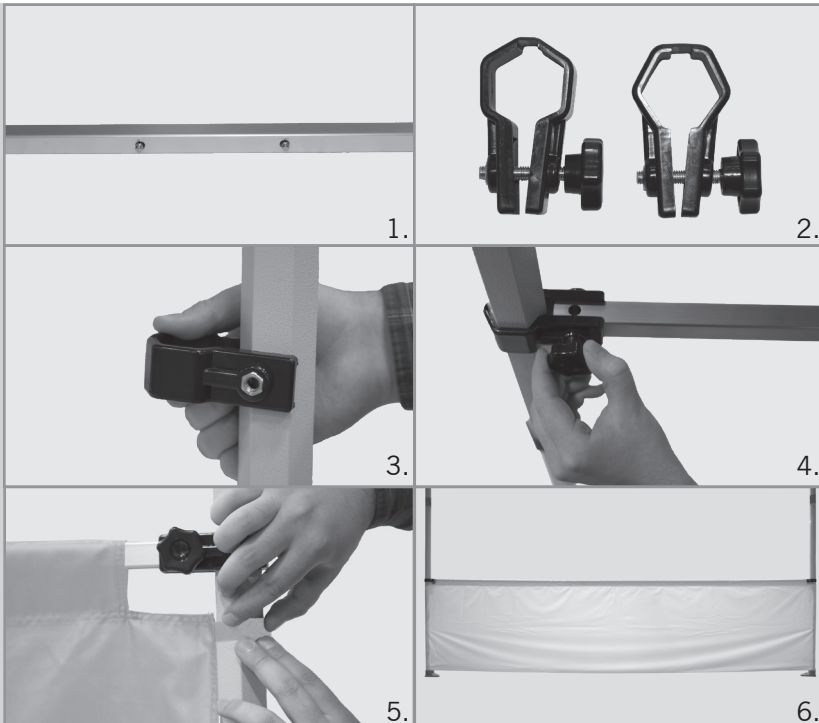

**NOTE: If attaching two or more half walls, you must stagger the height of the adjoining half walls or use a 90° corner clamp.**

1. Slide one support pole with the click button into the center support pole. Once the button snaps through the first hole, repeat this step with the second pole.  
  
Slide the half wall support bar through the print's pole sleeve. The support bar should go through the entire pole sleeve, with both ends of the pole sticking out from either end of the half wall.
- 2-3. Attach the half wall clamps. Unscrew the knobs completely from the clamps and slip the clamps around the tent legs.
4. Place the appropriate end of the half wall support bar through the opening of the clamp. Place the tightening knob into the open holes and hand tighten the knob. Repeat this step with the second clamp and support pole.
- 5-6. Secure the hook-and-loop adhesive tabs of the half wall around the tent legs.

**DISCLAIMER:** Tents should always be staked down with Premium Tent Stake Kit and weighed down. Tents should not be used in inclement weather, including thunderstorms, heavy rains, lightning, and high winds. No grill or any type of open flame is to be used under or near the tent. User must read and observe assembly instructions. If this is not done correctly, it may result in damage to the unit, injury, or death, and all warranties will be void. All warranties will be void if hardware is used with any print not produced by us. Properly care for prints to keep them in great condition. Prints should never be dragged along the ground or stored without being properly folded and free from moisture. Make sure print is completely dried from any weather, and fold and store in a clean, dry place. We don't recommend storing print on frame.



### ASSEMBLY HARDWARE

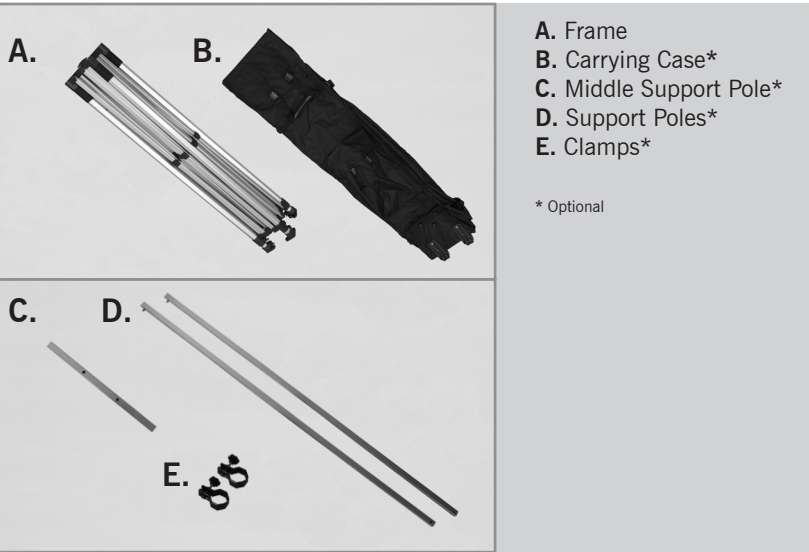

### ASSEMBLY

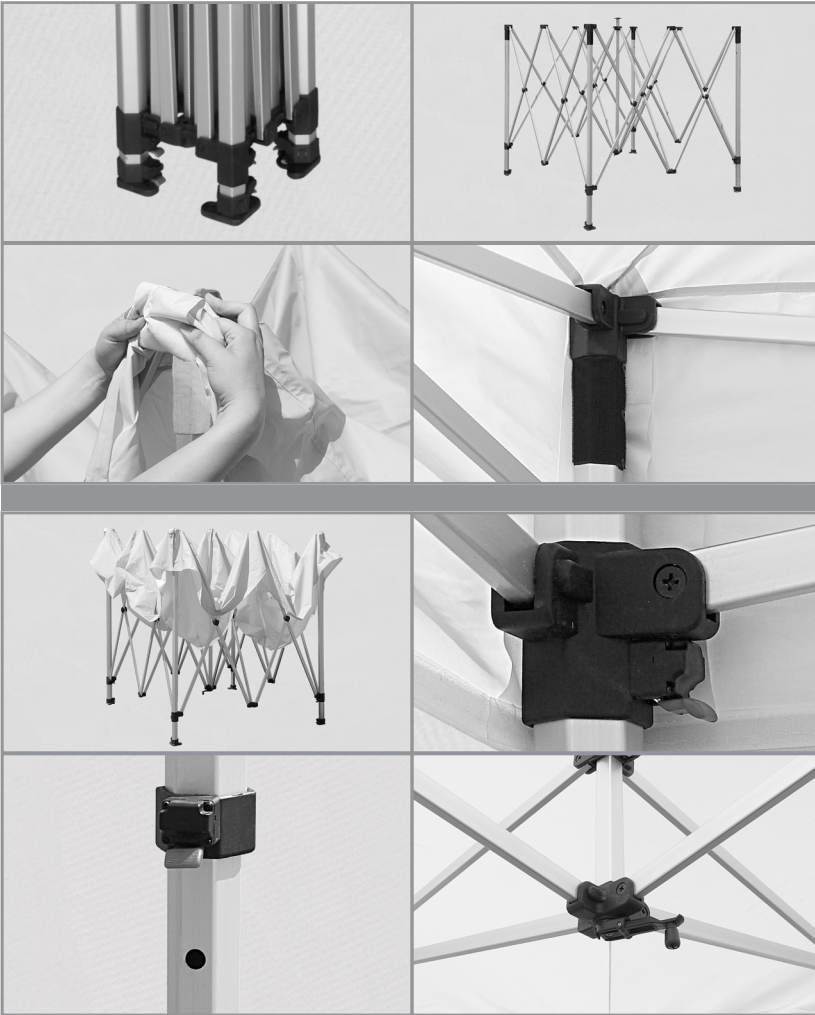

**NOTE: It is recommended to use at least two people for the tent assembly.**

1. Place the frame (A) into the location chosen for assembly. Make sure the feet of the frame (A) are on the ground.
2. Expand the frame (A) outward, but not fully, and place the print over the frame (A). Make sure the print is facing the correct direction and the corners of the print line up with the correct corners of the frame (A).
3. Wrap the hook-and-loop adhesive tabs, located on the inside of the print, around all the main posts on the frame (A).
4. Completely expand the frame (A) outward. The locking clips will snap into place to indicate full expansion of the frame (A).
5. Pull up the legs of the tent to the desired height, making sure the locking clips snap into place. Standing on base during this step makes it easier.
6. Extend the canopy to full height by using the rooftop crank adjustment. It will also tighten the print for a wrinkle-free display.

**NOTE: Remove print prior to collapsing and storing frame. Do not store with print on. Treat printed canopy with care to avoid scratching.**

**DISCLAIMER:** Tents should always be staked down with Premium Tent Stake Kit and weighed down. Tents should not be used in inclement weather, including thunderstorms, heavy rains, lightning, and high winds. No grill or any type of open flame is to be used under or near the tent. User must read and observe assembly instructions. If this is not done correctly, it may result in damage to the unit, injury, or death, and all warranties will be void. All warranties will be void if hardware is used with any print not produced by us. Properly care for prints to keep them in great condition. Prints should never be dragged along the ground or stored without being properly folded and free from moisture. Make sure print is completely dried from any weather, and fold and store in a clean, dry place. We don't recommend storing print on frame.



### ASSEMBLY OF WALL(S) - OPTIONAL

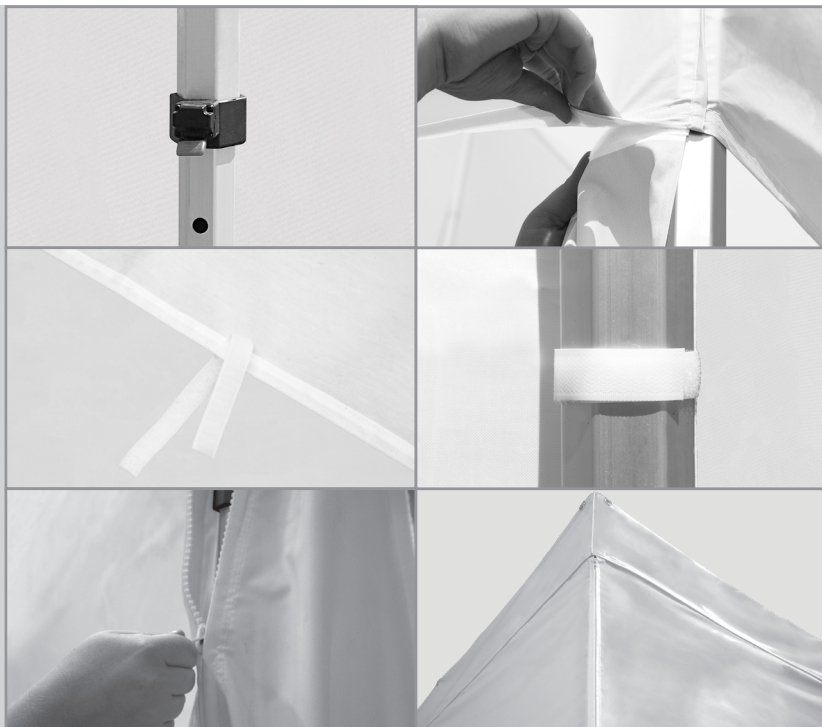

1. When adding the wall(s) to the tent, the legs on the frame (A) must be at their maximum extension height.
2. Attach the wall(s) to the valance on the tent roof using the hook-and-loop adhesive.
3. Secure the sides of the wall(s) by wrapping the hook-and-loop adhesive tabs around the tent legs.
4. If the tent wall features zippers, walls can be connected by closing the zipper from bottom to the top.

### ASSEMBLY OF HALF WALL(S) - OPTIONAL

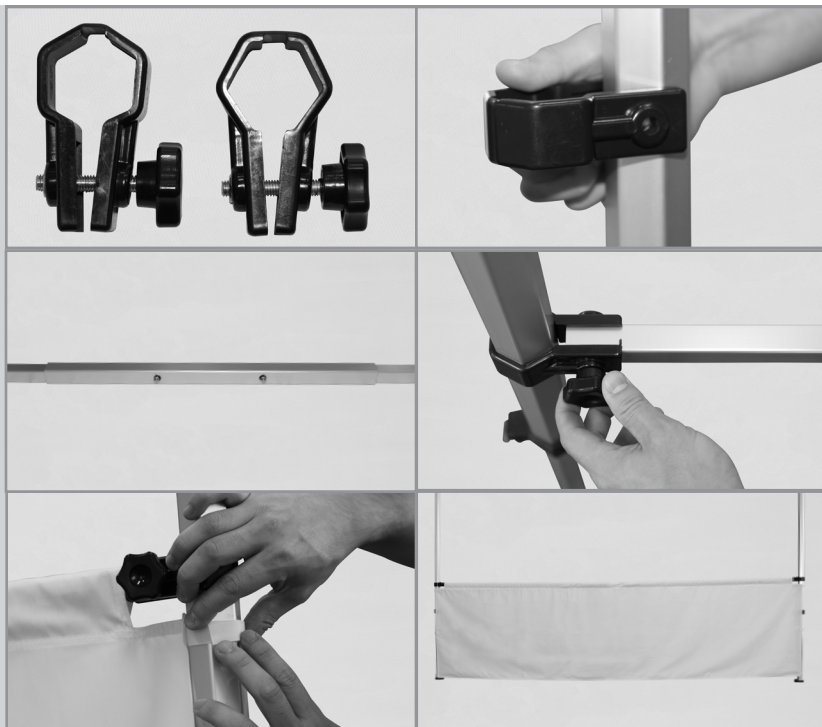

**NOTE: If attaching two or more half walls, you MUST stagger the height of ADJOINING half walls.**

1. Slide one support pole (D) with the click button into the pole with just holes (C). Once the buttons snap through the first hole repeat this step with the second support pole (D).
2. Slide the half wall support bar through the print's pole sleeve. The support bar should go through the entire pole sleeve, with both ends of the pole sticking out from either end of the half wall.
3. Attach the half wall clamps. Unscrew the knobs completely from the clamps (E) and slip the clamps (E) around the tent legs.
4. Place the appropriate end of the half wall support bar through the opening of the clamp. Place the tightening knob into the open holes and hand tighten the knob. Repeat this step with the second clamp and support pole.
5. Secure the hook-and-loop adhesive tabs of the half walls around the tent legs.

**DISCLAIMER:** Tents should always be staked down with Premium Tent Stake Kit and weighed down. Tents should not be used in inclement weather, including thunderstorms, heavy rains, lightning, and high winds. No grill or any type of open flame is to be used under or near the tent. User must read and observe assembly instructions. If this is not done correctly, it may result in damage to the unit, injury, or death, and all warranties will be void. All warranties will be void if hardware is used with any print not produced by us. Properly care for prints to keep them in great condition. Prints should never be dragged along the ground or stored without being properly folded and free from moisture. Make sure print is completely dried from any weather, and fold and store in a clean, dry place. We don't recommend storing print on frame.

