

## ASSEMBLY HARDWARE

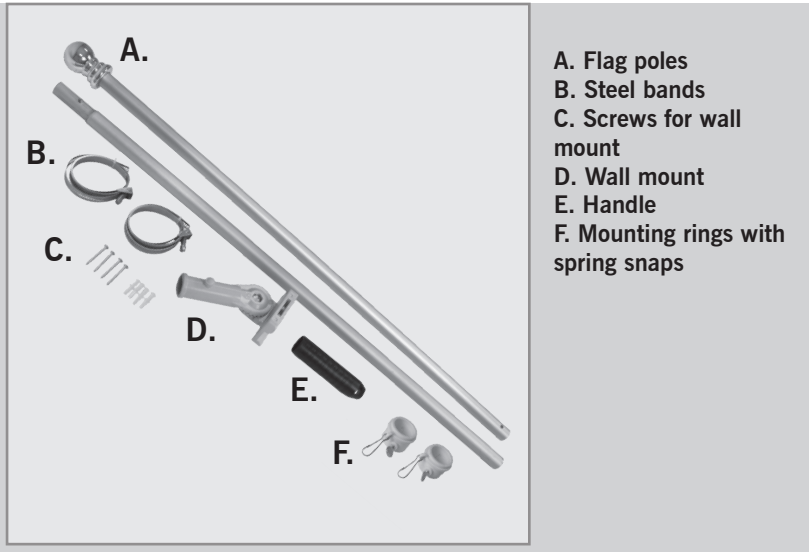

## POLE & FLAG ASSEMBLY

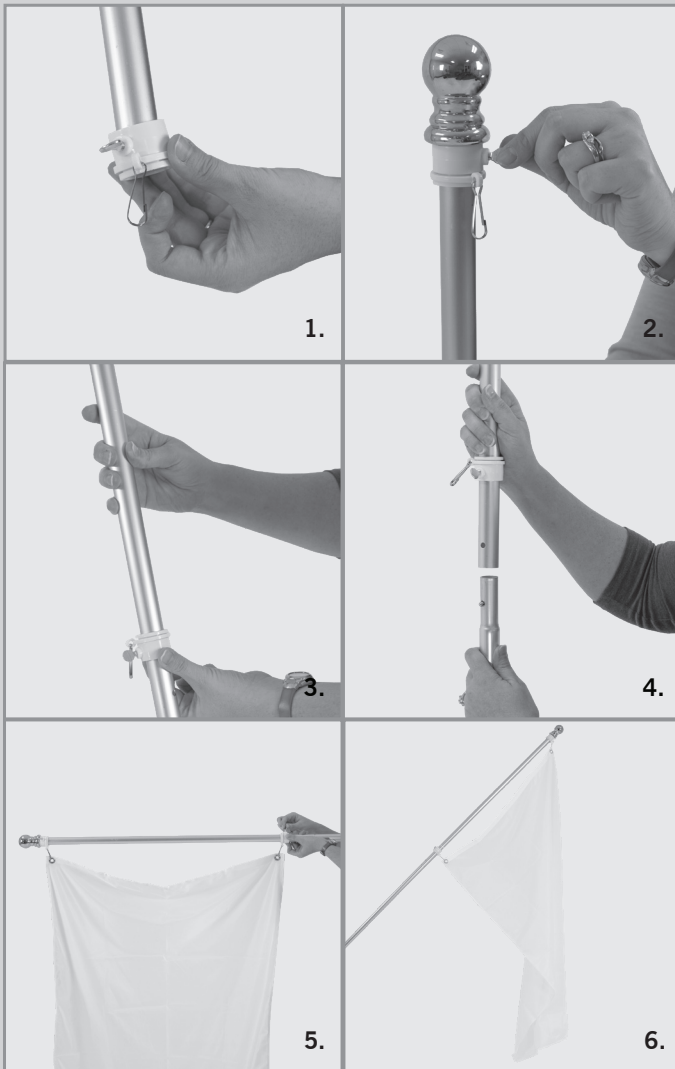

1. Slide a mounting ring to the top of the flagpole. Make sure the spring snap is facing downwards.

2. Tighten the mounting ring against the pole using the screw.

3. Slide the second mounting ring onto the flagpole. Make sure the spring snap is facing upwards. Space out the second ring so that it is equal to the height of the flag, and then move it up the pole approximately 2 inches. Tighten the mounting ring against the pole.

4. Connect the two flagpole halves using the snap-and-click buttons.

5. Clip the spring snaps onto the flag's metal grommets.

6. Flag & pole assembly is now complete! Move on to the next page to view further assembly instructions.

# 6FT FLAGPOLE

Assembly Instructions | R1.122618

## HAND HELD ASSEMBLY

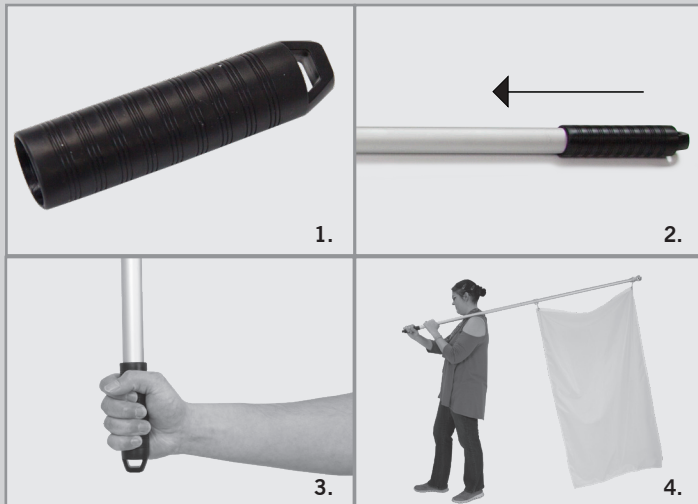

1. Locate the black flagpole handle.
2. Attach the handle to the flagpole by pushing it onto the pole until it fits snugly.
3. Grip flag pole handle tightly to ensure snug fit.
4. Carry flag pole with two hands when transporting.

## WALL MOUNT ASSEMBLY



1. Gather flagpole wall mount and screws.
2. Screw wall mount into place with one screw in all four corners.
3. Insert the flagpole into the wall mount.
4. Adjust the angle of the flagpole.

## POLE MOUNT ASSEMBLY



1. Put the steel bands through the flagpole mount and around the pole the flagpole is being mounted to.
2. Tighten the screws on the steel bands.

# 20FT FLAGPOLE BASIC

Assembly Instructions | R1.043019

## ASSEMBLY HARDWARE

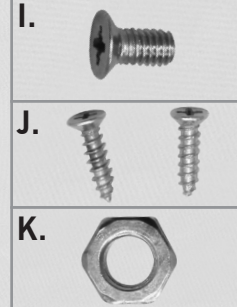
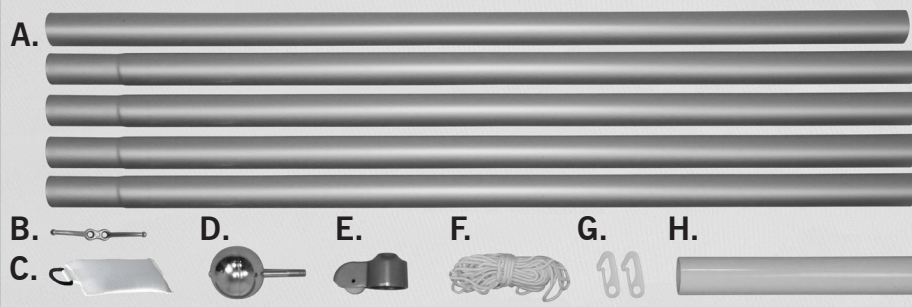

- A. 5 Aluminum Pole Segments
- B. Halyard
- C. Weight Bag \*8' x 5' flags only
- D. Finial
- E. Pole Cap
- F. Rope
- G. Plastic Snap Hooks
- H. PVC Ground Tube
- I. Machine Screw
- J. Self Tapping Screws
- K. Metal Nut

## ASSEMBLY

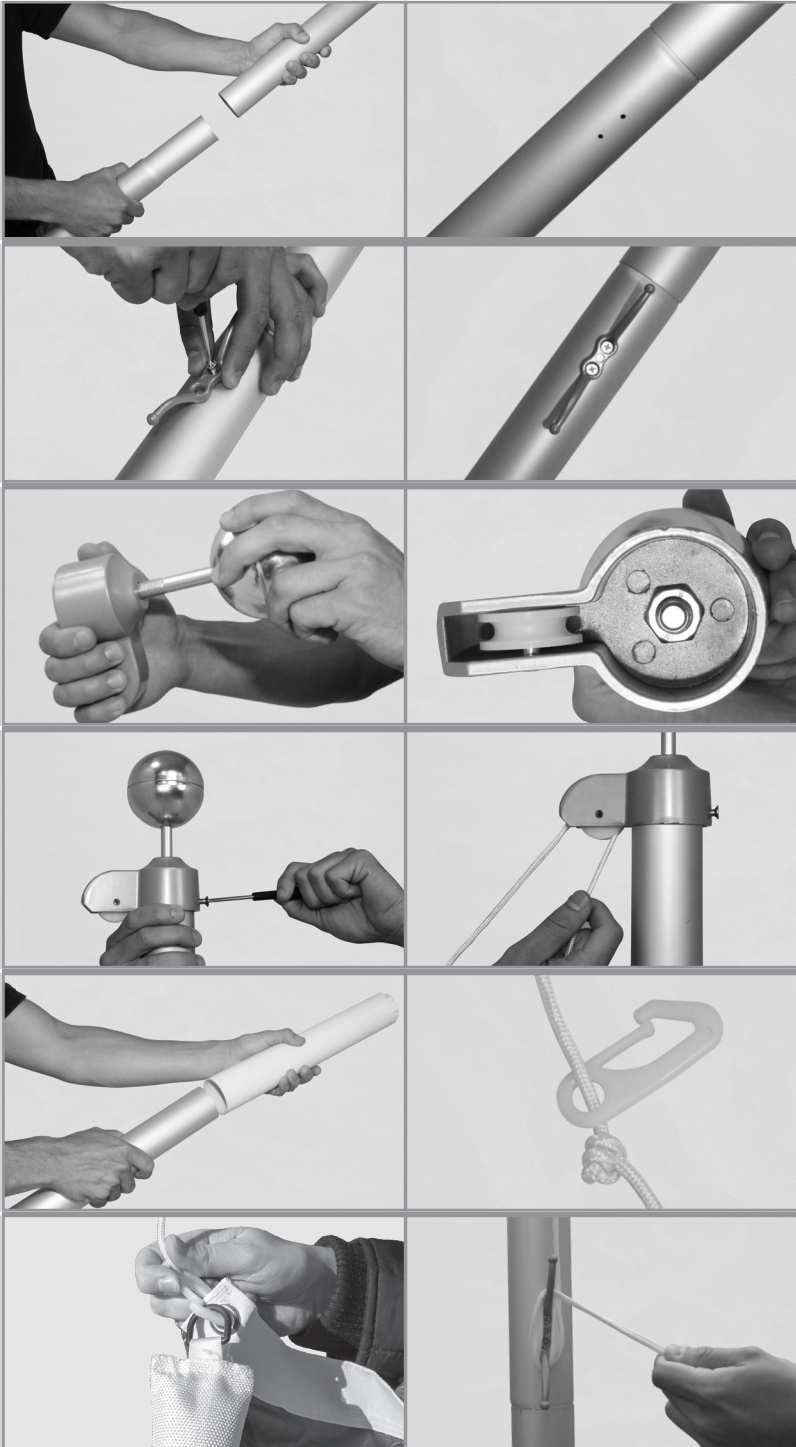

1. Install the aluminum pole segments making sure the segment with 2 pre-drilled holes is the bottom pole. The Aluminum pole segment with no tapered ends **MUST** be installed on the top.
2. Locate the 2 self tapping screws and halyard. Mount the halyard to the bottom Aluminum pole segment, where the 2 predrilled holes are located, with the 2 self tapping screws.
3. Screw the finial into the pole cap. Secure by screwing the metal nut onto the finial stem located on the underside of the pole cap.
4. Install the pole cap with finial to the top Aluminum pole segment using the machine screw.
5. Feed the rope through the pulley located on the pole cap.
6. Mount the flagpole on desired base. The provided PVC ground tube can be inserted into the ground for mounting or used with other selected bases.
7. Slide a plastic snap hook onto the rope and tie a knot below it. Attach top grommet of flag to the plastic snap hook.
8. Pull the flag until taut and tie a second knot in the rope just above the bottom grommet. Slide on a plastic snap hook and attach the bottom grommet of the flag. For 8'x5' flags only, attach the weight bag to the plastic hook. Tie the loose ends of rope together.
9. Hoist flag to the proper position and wrap the excess around the halyard.

**NOTE:** All Aluminum pole segments (A) **DO NOT** have to be used. You may install between 2-5 segments.

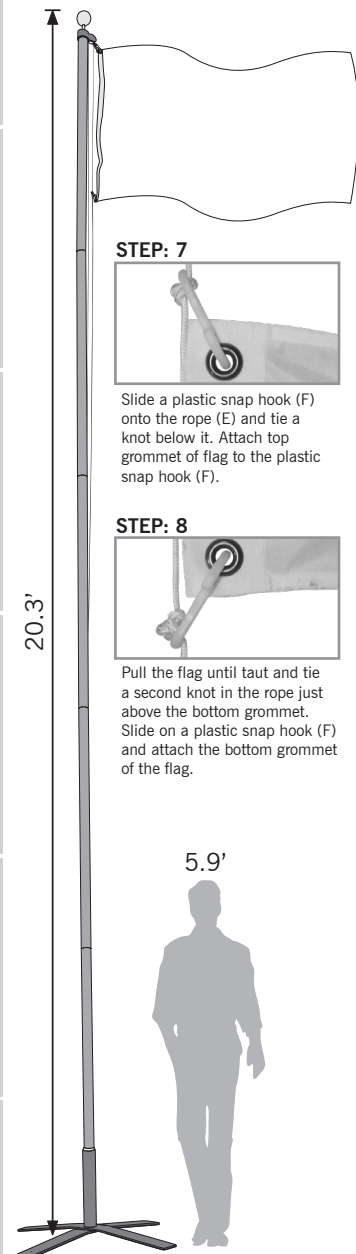

Do not fly your Flagpole Basic in extreme winds (any wind speed exceeding what is listed below) and/or thunderstorms. Single-Reverse: 30mph or 6bft, Double-Sided: 23mph or 5bft. Do not use near overhead wires. User must read and observe construction sheet. If this is not done correctly it may result in damage to the unit, injury, or death, and all warranties will be void. All warranties will be void if the Flagpole Basic hardware is used with any flag not produced by us.

